



### Product Summary

$V_{(BR)DSS}$	$R_{DS(on)TYP}$	$I_D$
100V	100m $\Omega$ @10V	3A
	138m $\Omega$ @4.5V	

### Feature

- Split Gate Trench Technology
- Low  $R_{DS(ON)}$
- Low Gate Charge

### Application

- Load Switch
- DC/DC Converter

### MARKING:

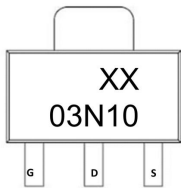

03N10 = Device Code  
XX = Date Code

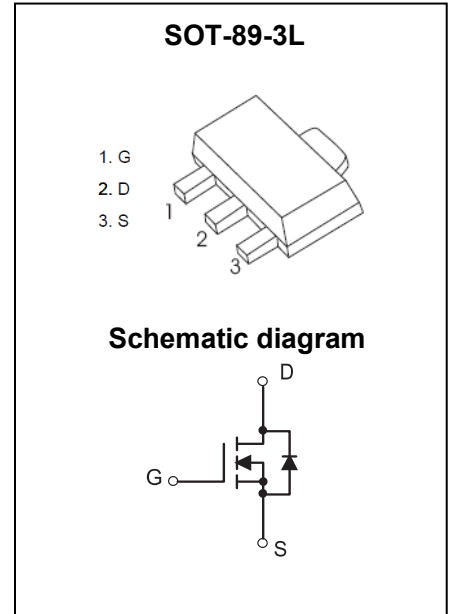

### ABSOLUTE MAXIMUM RATINGS ( $T_A = 25^\circ\text{C}$ unless otherwise noted)

Parameter	Symbol	Value	Unit
Drain - Source Voltage	$V_{DS}$	100	V
Gate - Source Voltage	$V_{GS}$	$\pm 20$	V
Continuous Drain Current <sup>1,5</sup>	$I_D$	3	A
Pulsed Drain Current <sup>2</sup>	$I_{DM}$	12	A
Power Dissipation <sup>4,5</sup>	$P_D$	1.5	W
Thermal Resistance from Junction to Ambient <sup>5</sup>	$R_{\theta JA}$	83	$^\circ\text{C}/\text{W}$
Junction Temperature	$T_J$	150	$^\circ\text{C}$
Storage Temperature	$T_{STG}$	-55~ +150	$^\circ\text{C}$

## MOSFET ELECTRICAL CHARACTERISTICS ( $T_A = 25^\circ\text{C}$ unless otherwise noted)

Parameter	Symbol	Test Condition	Min	Type	Max	Unit
<b>Off Characteristics</b>						
Drain - Source Breakdown Voltage	$V_{(BR)DSS}$	$V_{GS} = 0V, I_D = 250\mu A$	100			V
Zero Gate Voltage Drain Current	$I_{DSS}$	$V_{DS} = 100V, V_{GS} = 0V$			1	$\mu A$
Gate - Body Leakage Current	$I_{GSS}$	$V_{GS} = \pm 20V, V_{DS} = 0V$			$\pm 100$	nA
<b>On Characteristics<sup>3</sup></b>						
Gate Threshold Voltage	$V_{GS(th)}$	$V_{DS} = V_{GS}, I_D = 250\mu A$	1	1.9	3	V
Drain-source On-resistance	$R_{DS(on)}$	$V_{GS} = 10V, I_D = 3A$		100	140	m $\Omega$
		$V_{GS} = 4.5V, I_D = 3A$		138	180	
<b>Dynamic Characteristics</b>						
Input Capacitance	$C_{iss}$	$V_{DS} = 45V, V_{GS} = 0V, f = 1MHz$		202		pF
Output Capacitance	$C_{oss}$			37		
Reverse Transfer Capacitance	$C_{rss}$			5		
Gate Resistance	$R_g$	$V_{DS} = 0V, V_{GS} = 0V, f = 1MHz$		1.9		$\Omega$
<b>Switching Characteristics</b>						
Total Gate Charge	$Q_g$	$V_{DS} = 40V, V_{GS} = 10V, I_D = 3A$		5.4		nC
Gate-source Charge	$Q_{gs}$			0.8		
Gate-drain Charge	$Q_{gd}$			1.9		
Turn-on Delay Time	$t_{d(on)}$	$V_{DD} = 50V, V_{GS} = 10V, R_L = 1.25\Omega, R_G = 3\Omega$		9		ns
Turn-on Rise Time	$t_r$			25		
Turn-off Delay Time	$t_{d(off)}$			24		
Turn-off Fall Time	$t_f$			31		
<b>Source - Drain Diode Characteristics</b>						
Diode Forward Voltage <sup>3</sup>	$V_{SD}$	$V_{GS} = 0V, I_S = 1A$			1.2	V

Notes :

- 1.The maximum current rating is limited by package.
- 2.Pulse Test : Pulse Width  $\leq 10\mu s$ , duty cycle  $\leq 1\%$ .
- 3.Pulse Test : Pulse Width  $\leq 300\mu s$ , duty cycle  $\leq 2\%$ .
- 4.The power dissipation  $P_D$  is limited by  $T_{J(MAX)} = 150^\circ\text{C}$ .
- 5.Device mounted on 1in<sup>2</sup> FR-4 board with 2oz. Copper, in a still air environment with  $T_A = 25^\circ\text{C}$ .

## Typical Characteristics

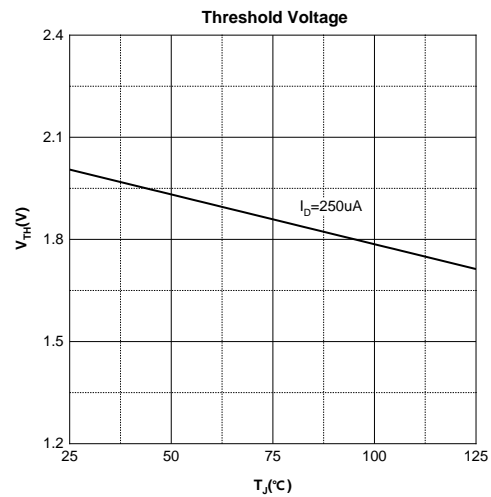
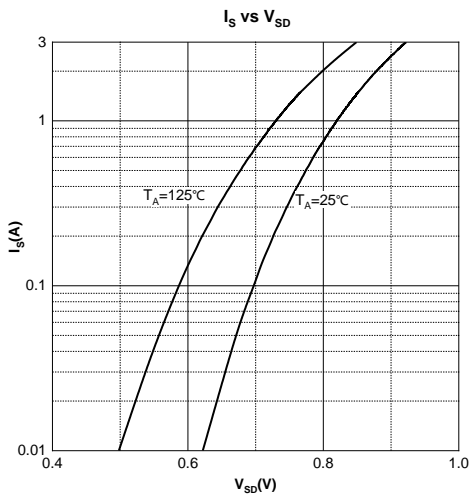
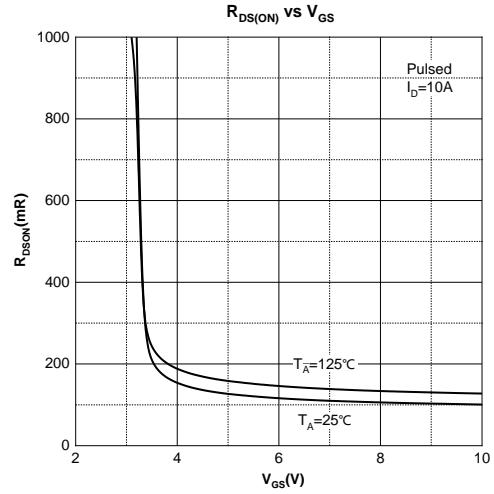
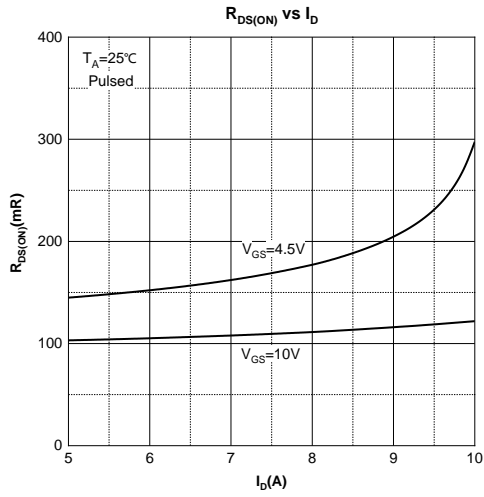
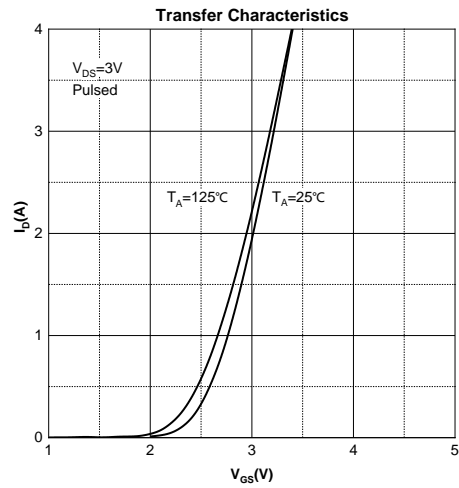
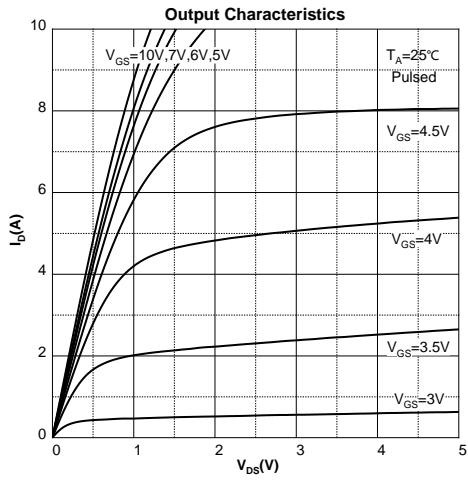

## SOT-89-3L Package Information

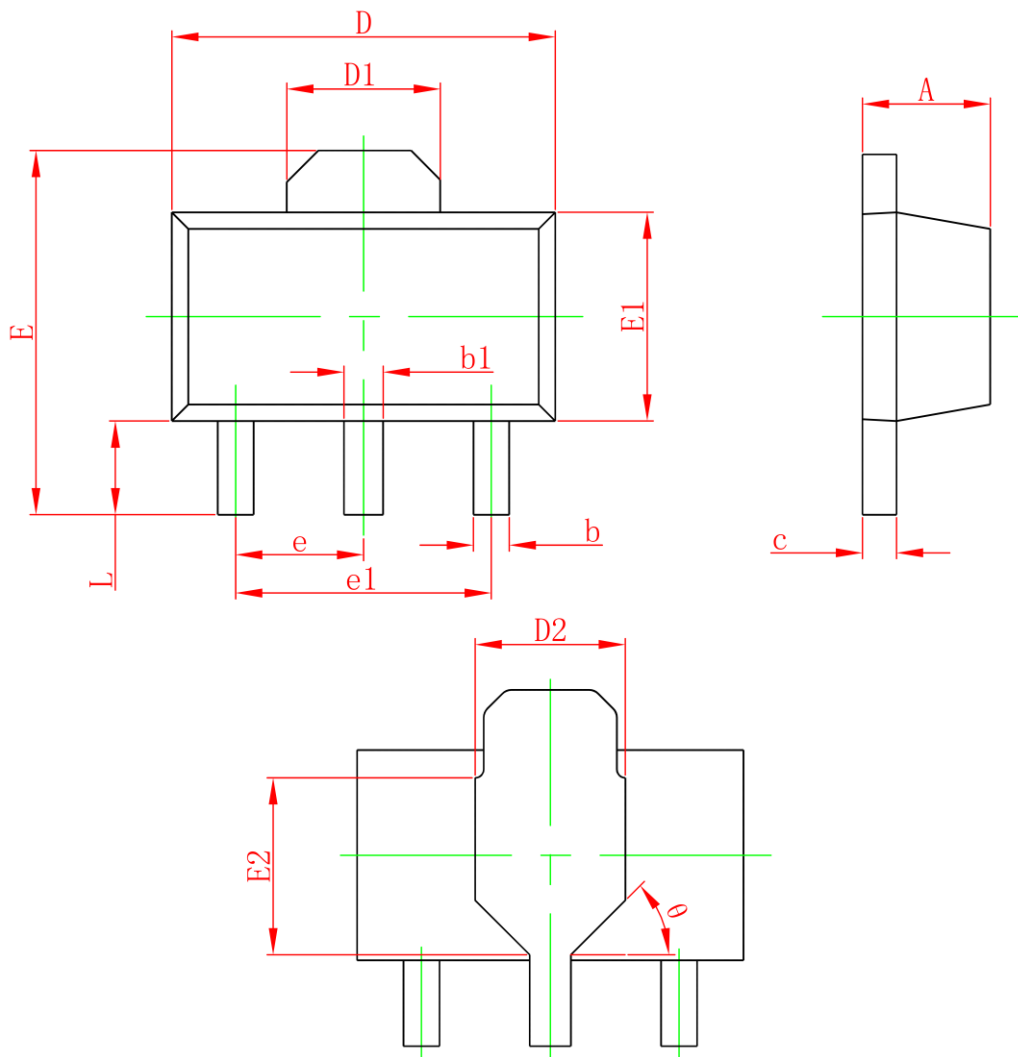

Symbol	Dimensions In Millimeters		Dimensions In Inches	
	Min.	Max.	Min.	Max.
A	1.400	1.600	0.055	0.063
b	0.320	0.520	0.013	0.020
b1	0.380	0.580	0.015	0.023
c	0.350	0.500	0.014	0.020
D	4.400	4.600	0.173	0.181
D1	1.650REF		0.065REF	
D2	1.650	1.850	0.065	0.073
E	3.900	4.400	0.154	0.173
E1	2.300	2.600	0.091	0.102
E2	1.900REF		0.075REF	
e	1.500TYP		0.059TYP	
e1	3.000TYP		0.118TYP	
L	0.900	1.200	0.035	0.047
θ	45°		45°	